

# Development of Engineered Ge Substrate for Space Solar Cells: Project status and outlook

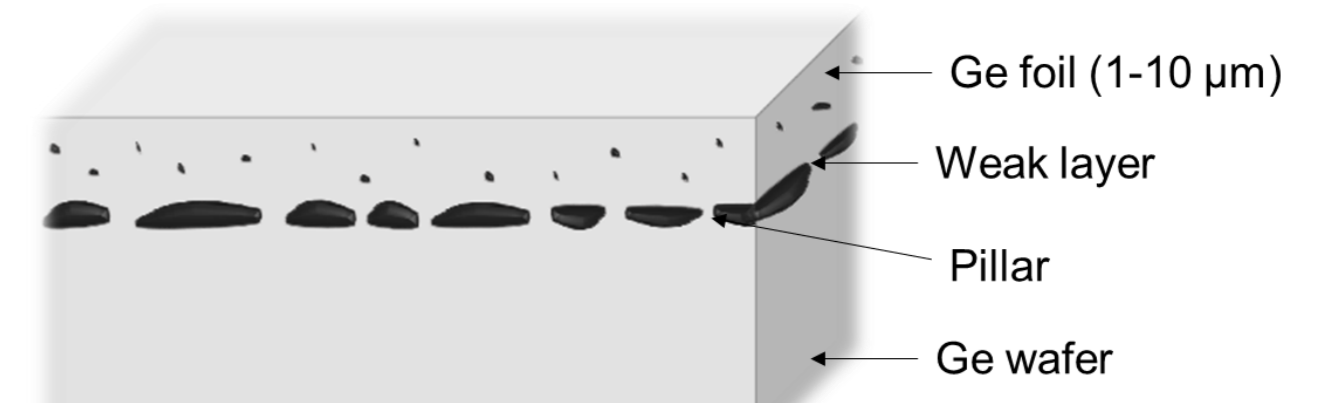

## Introduction

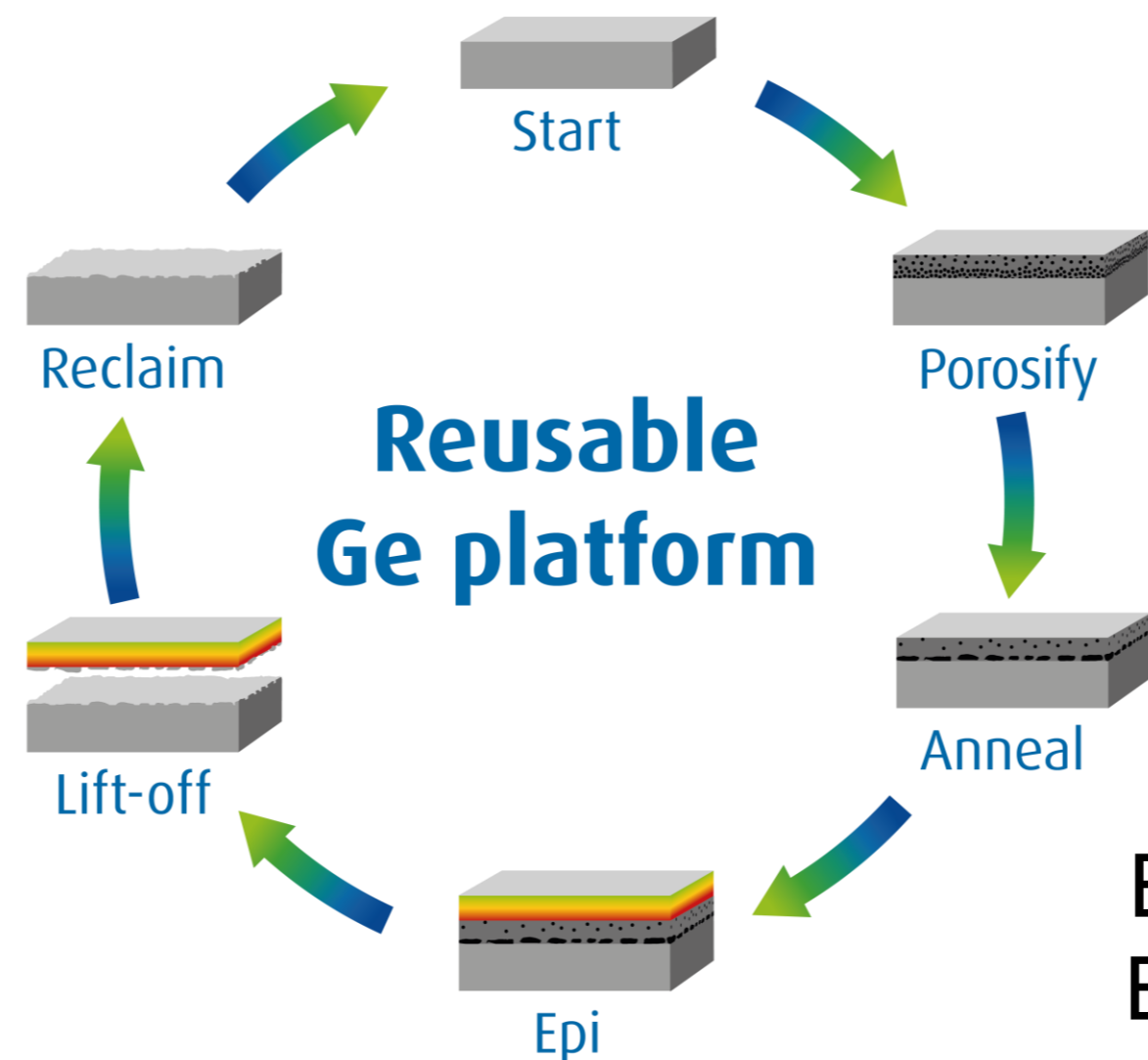
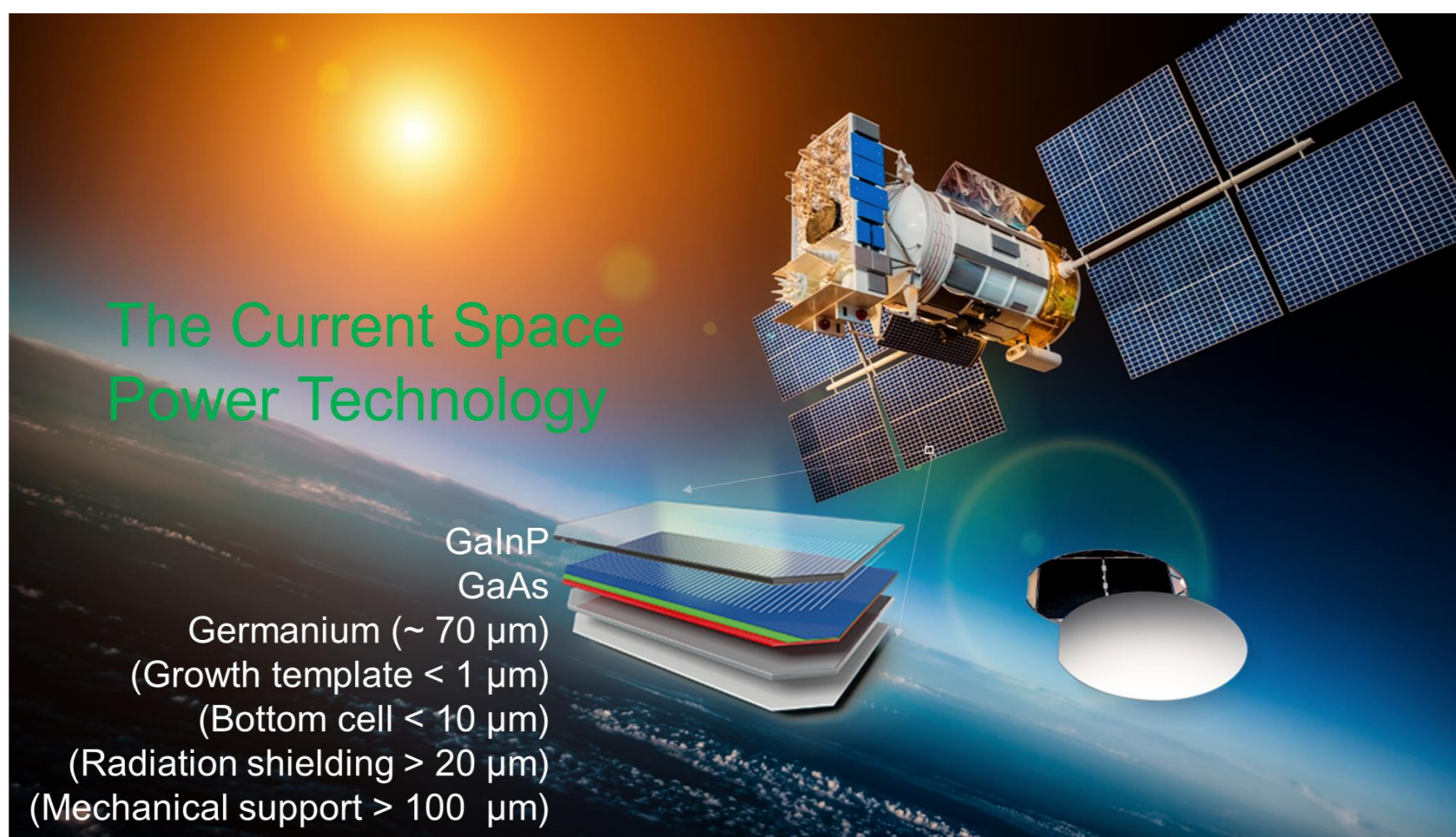

Engineered Ge substrate for space solar cells: Enabling efficient and sustainable usage of Ge

## Current state

### Baseline process for 4" wafers

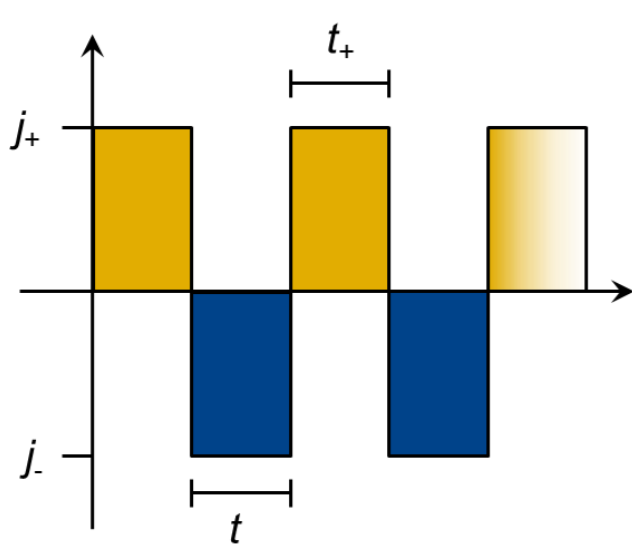

Process

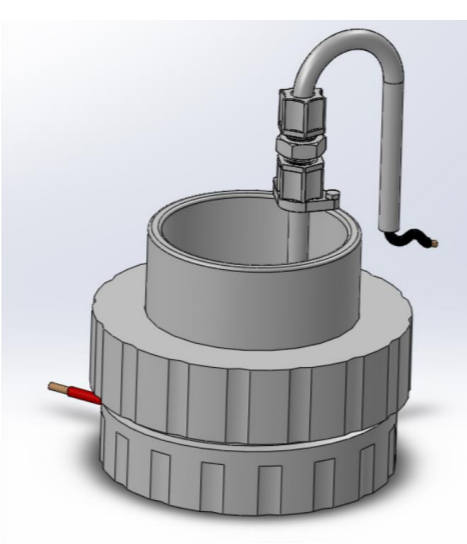

Tool

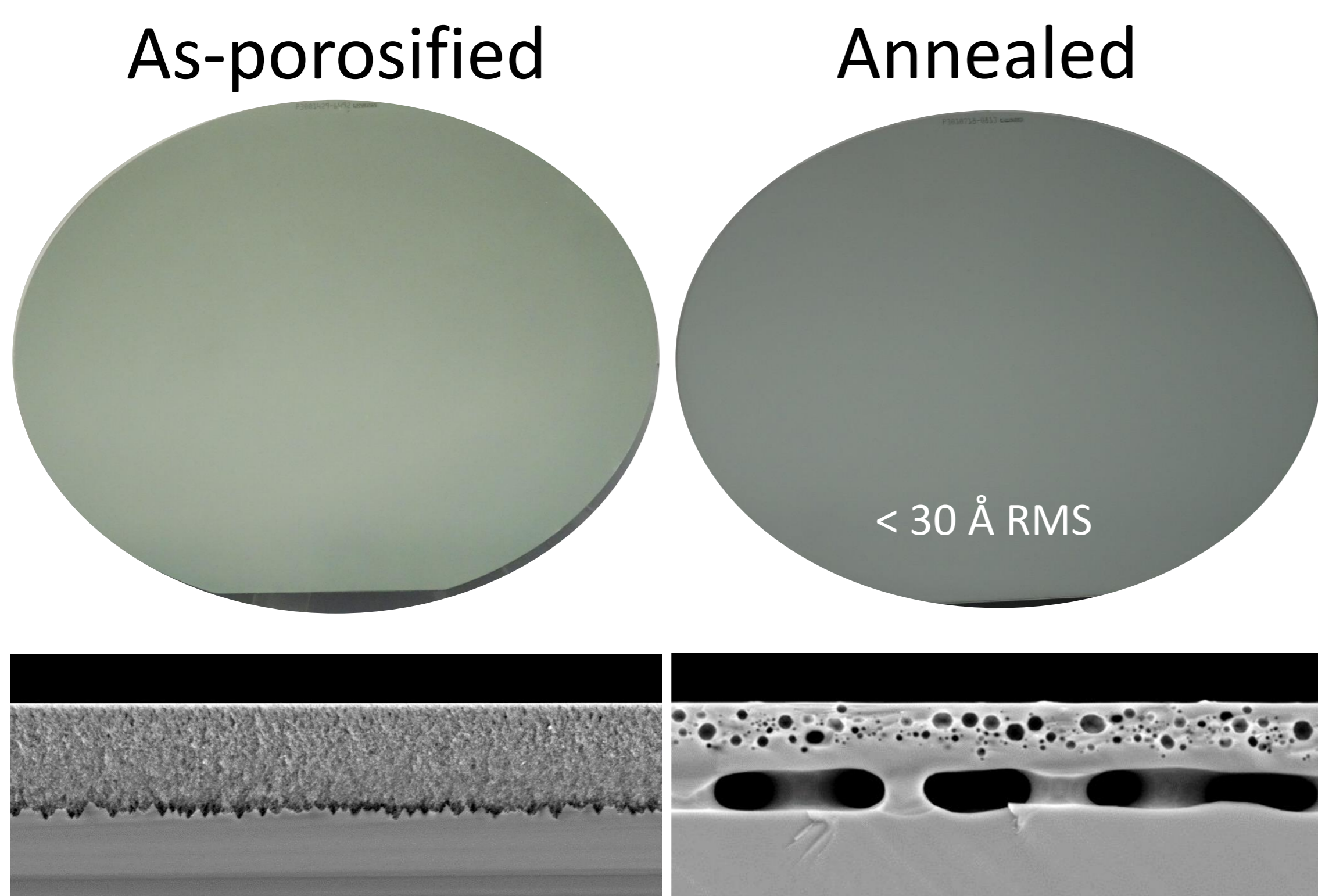

## Scaling up

### Joint development of a semi-automated porosification tool for 6" Ge wafers

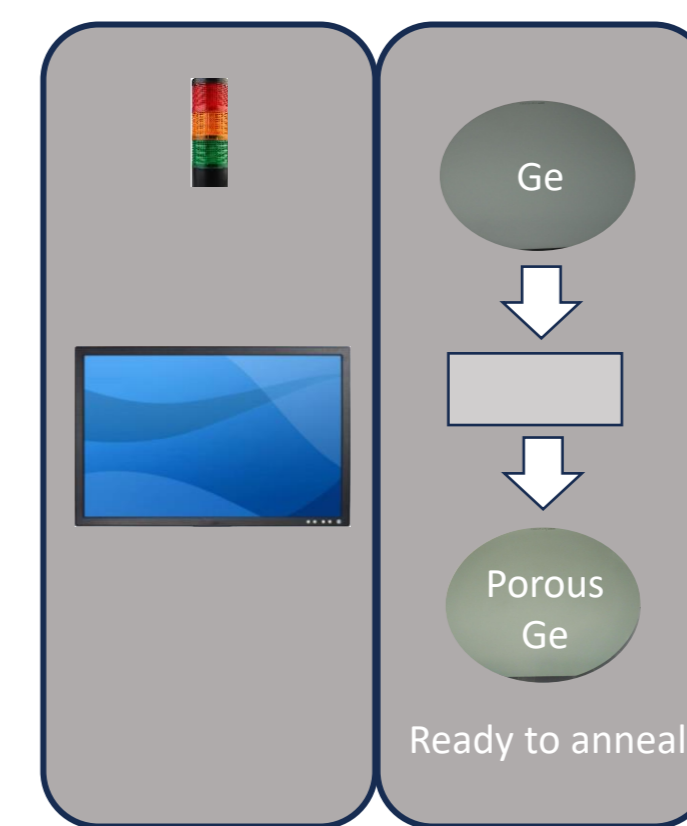

### High-throughput, high-η Ge epitaxy

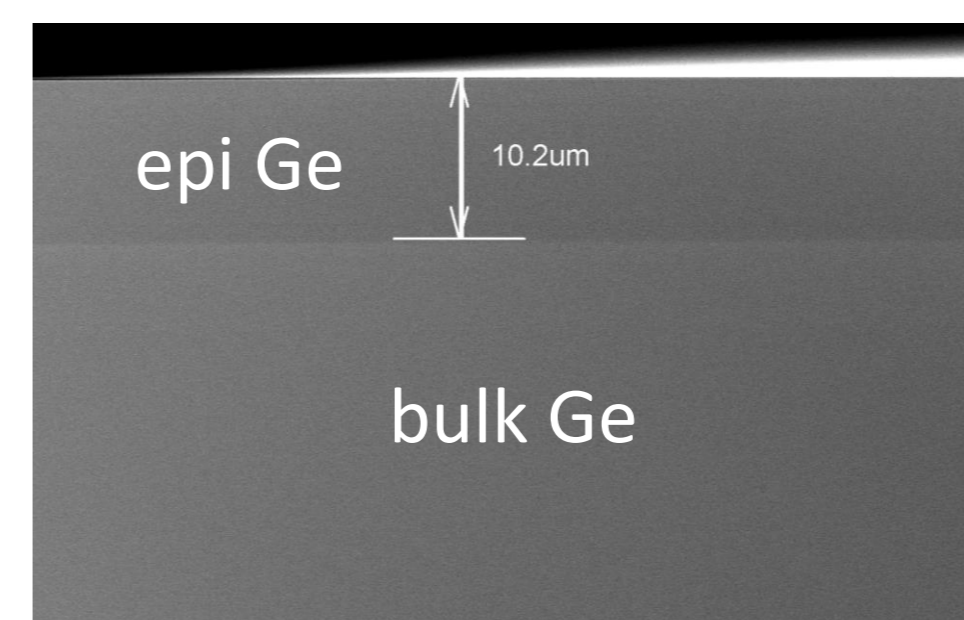

## Roadmap

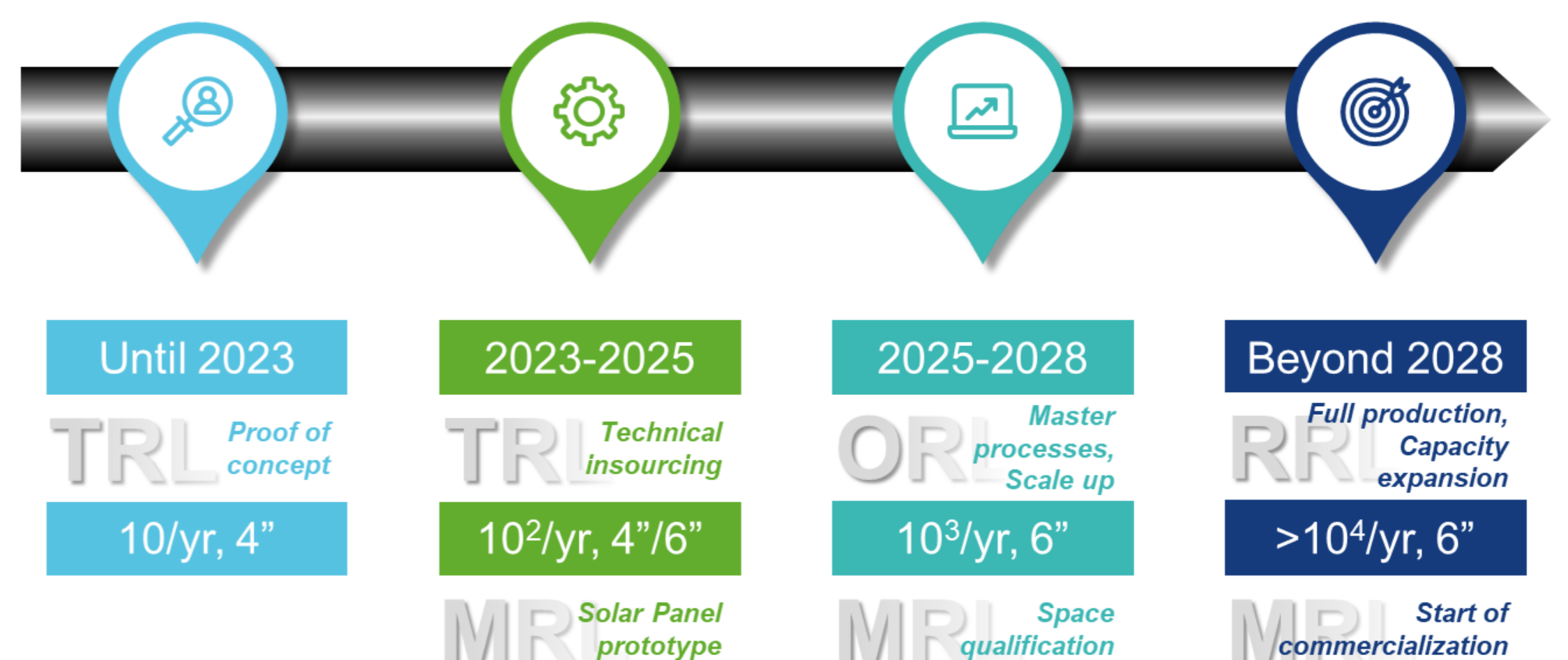

## Partners



## Team members

Name: Kristof Dessen, Rajiv Sharma, Jinyoun Cho, Alexandre Chapotot, Robin Vanuytven, Priyanka Proost, Bendix De Meulemeester, Geert Vandenhoeck  
 Unit: Electro-Optic Materials, Strategic Business Development, Olen, Belgium

## Supported by



This project was financially supported by European Space Agency (ESA) with a contract No. 4000143073/23/NL/MGu. The view expressed herein can in no way be taken to reflect the official opinion of ESA.